

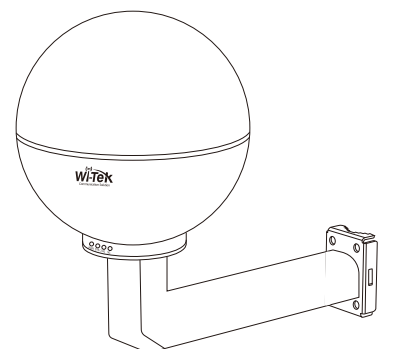

Quick Installation Guide

AC 1200M Outdoor Mesh Wi-Fi



WI-AP718M
Hardware Version: V2.0

www.wireless-tek.com

1.Packing Content

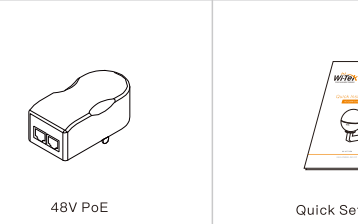
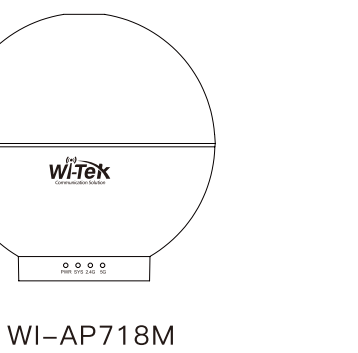

2. Appearance Overview

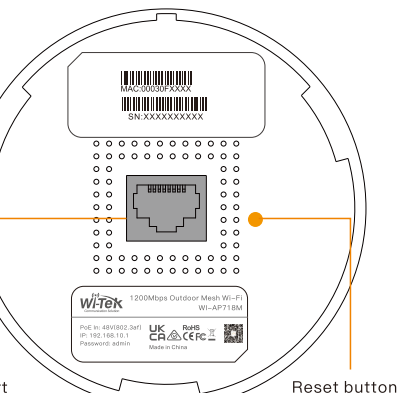
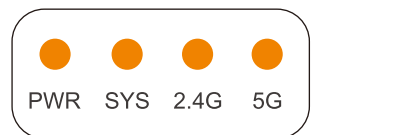

• Port and Button

LED	Description
PWR	On: the device is powered up. Off: the device is powered off.
SYS	On: the device is running normally. Off: the device is running abnormal.
2.4G	On:Wi-Fi or Mesh is normal Off:Wi-Fi or Mesh is abnormal
5G	On:Wi-Fi is normal Off:Wi-Fi is abnormal

3.Device Installation

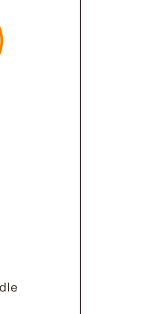
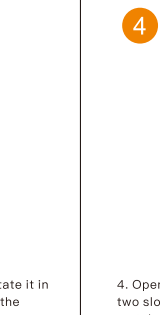
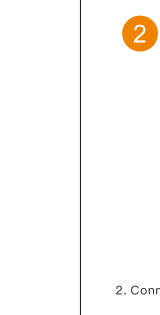
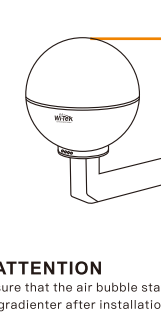
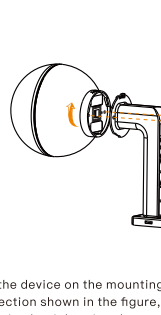
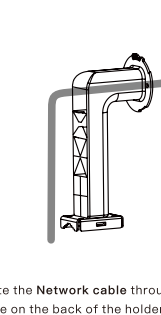

4.Setup new Master Node



Please connect devices according to the above topology.

Note: The WI-AP718M V2 version is equipped with firmware that supports EasyMesh, so its default operating mode is set to router mode.

Follow the steps for quick Master node configuration, using initial setup wizard:

Step 1: Please connect devices according to the topology above and make sure they are all powered on.

Step 2: Launch web browser then enter the device IP address 192.168.10.1 to go into login UI, and specify the default login key: admin.

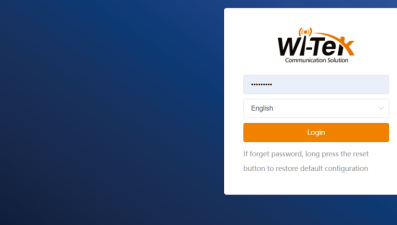

5.Adding new slave node

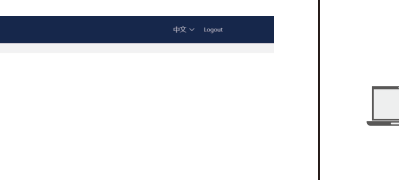

Note: No any setup for slave node during the period of mesh pairing.

Step 5: After finishing configuration steps above, please power on the slave node and enter into the Master MESH function UI. Then click Search button to find secondary Mesh Wi-Fi.

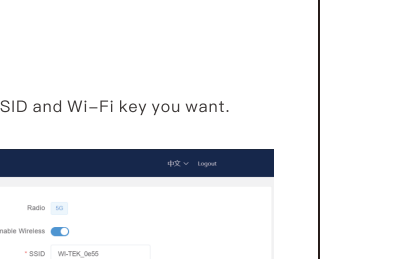

Step 6: When the bar appears as below and shows the secondary Mesh Wi-Fi status is online, it indicates Mesh pairing is completed successfully.

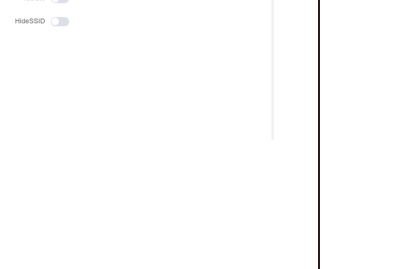

6.Quick Setup Wizard on Wi-Tek Cloud APP

• 1.Go in the APP UI as followings and then create a EasyMesh network project.

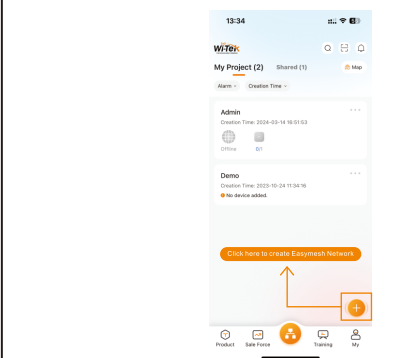

• 2.Please follow steps as followings : Power on your Mesh device and connect it to the Internet, then restore it to the factory.

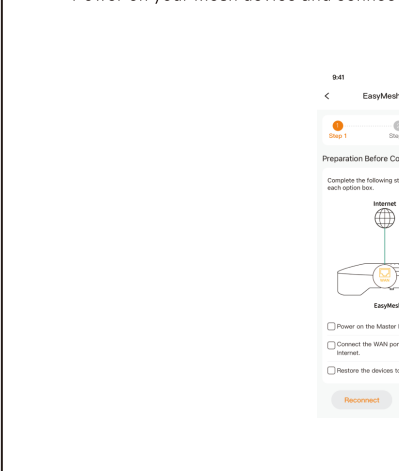

7.Connect your phone to Wi-Fi

• 3.Connect your phone to Wi-Fi Note: The initial SSID is starting with "WI-TEK_XXXX" and the default password is 88888888.

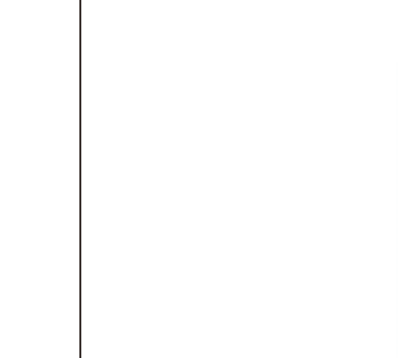

• 4.After completing the steps above, you can configure your network.

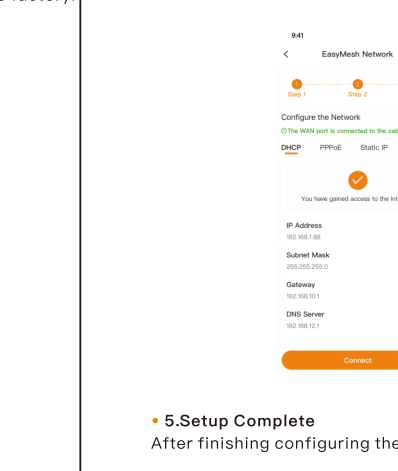

8.Setup Complete

After finishing configuring the network, your Mesh network is now up.

Warranty Card

Username	
Address	
Telephone No.	
Purchase Shop	
Purchase Address	
Product Model No.	
Purchase Time	
Serial No.	
Dealer Signature	

- If the product defects within three months after purchase, we will provide you with a new product of the same model.
- If the product defects within the three-year warranty period, we will provide professional maintenance service.
- Proof of purchase and a complete product serial number are required to receive any services guaranteed as part of the limited warranty.
- Any other defects that are not caused by workmanship or product quality, such as natural disasters, water damage, extreme thermal or environmental conditions, sticker damaged, warranty card loss will disqualify the product from limited warranty.



Wireless-Tek Technology Limited
 Address: Building 3, Units 1801-1807, 1812, Huaqiang Era Plaza, Tangwei Community, Fuhai Street, Bao'an District, Shenzhen City, Guangdong Province, China.
 Website:www.wireless-90
 Email:sales@wireless-tek.com
 Technical Support:tech@wireless-tek.com

